



## AL KAMEL SYSTEMS - PPTRACKER SYSTEM

---

Timekeeping Services | Race Control Solutions | TV Graphics | Rally Tracking  
Security Services | Road Book Services | Radio Systems | Turnkey Projects

The PPTracker System provided by Al Kamel Systems is a GPS tracking and Signaling system designed for all types of rally competitions and whose purpose is to improve the safety and visibility of participants.

Competing vehicles must arrive to Scrutineering with the S-CER kit supplied by Al Kamel Systems installed according to the instructions in this manual.

The acquisition of the kit must be processed through the Al Kamel Systems E-commerce: [pptracker-store.alkamelsystems.com](http://pptracker-store.alkamelsystems.com)

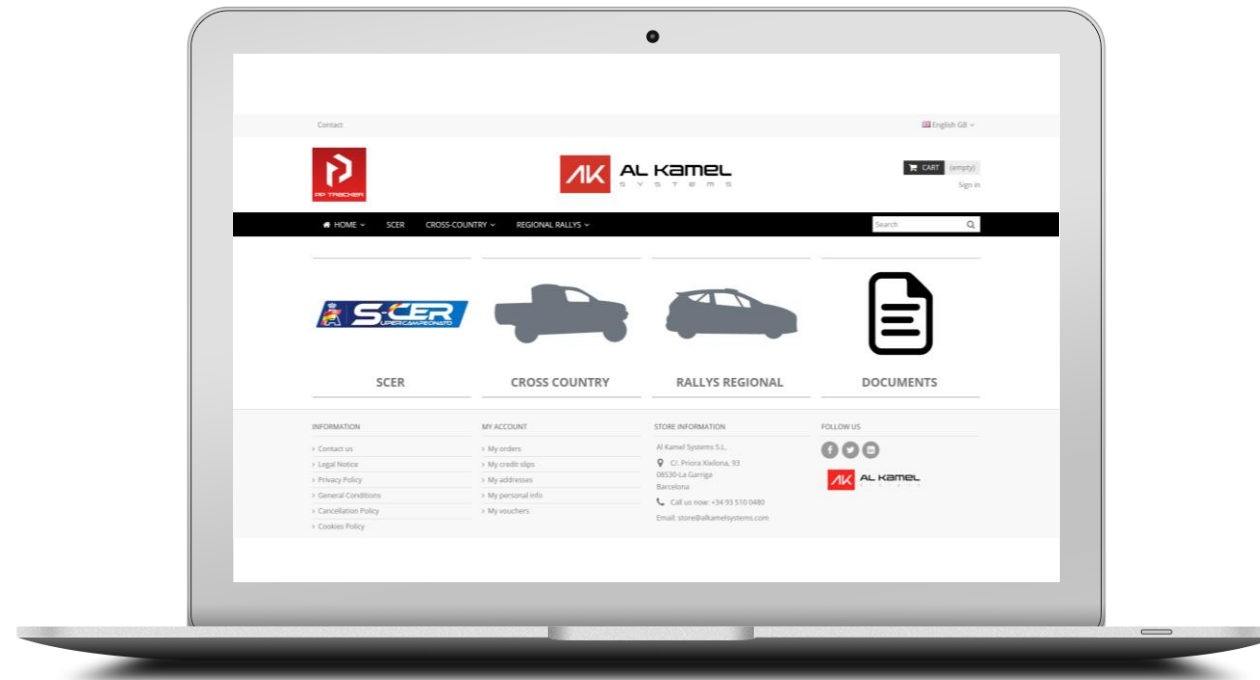

These elements are the components of the [S-CER kit](#) provided by Al Kamel Systems through its E-commerce website and that each team must install:

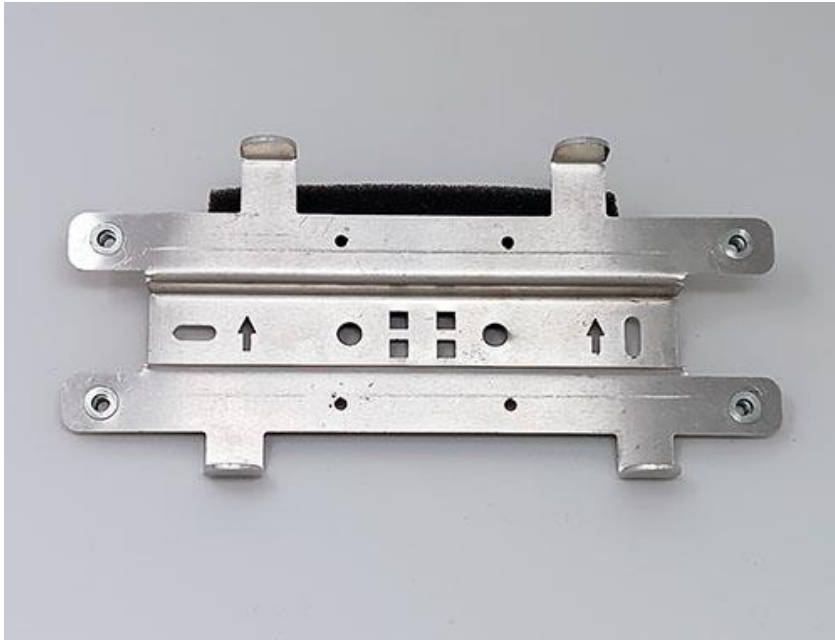

Image 1. [METALLIC BRACKET](#) (Ref. AKS 4069)



Image 2. [DUAL ANTENNA 3M](#) (Ref. AKS 4072)

These elements are the components of the [S-CER kit](#) provided by Al Kamel Systems through its E-commerce website and that each team must install:



Image 3. [POWER CABLE](#) 3M (Ref. AKS 4070)

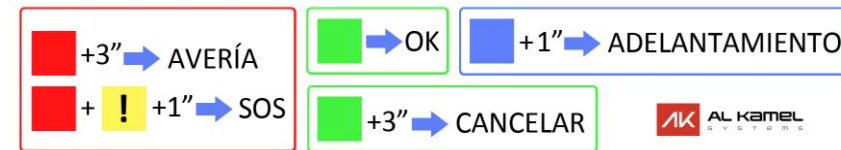
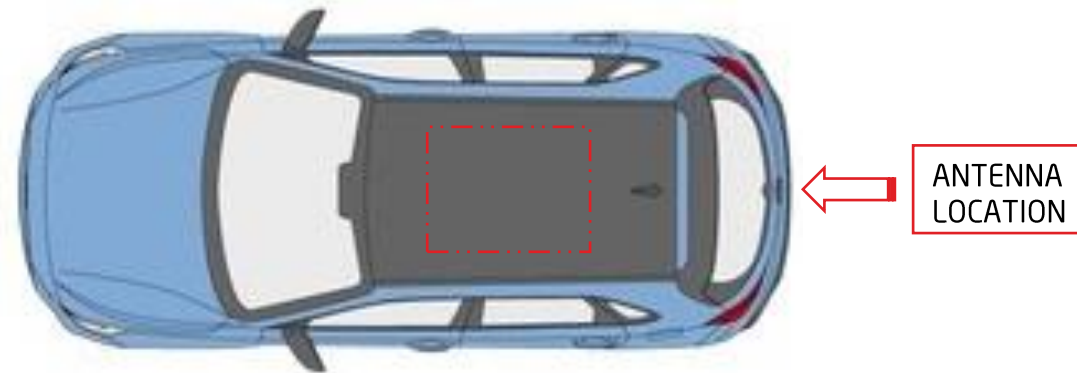

Image 4. SUMMARY STICKER

The antenna must be installed on the outside of the vehicle. It must be in contact with the bodywork and located at the highest part of it, where there is no element that hides it, helping to improve the reception and sending of the various signals managed by the PPTracker device, as shown below:



**Image 5. CORRECT LOCATION FOR THE ANTENNA**

Modification of the antenna supplied by Al Kamel Systems, including the installation of extensions, is strictly prohibited.

The PPTracker device must be placed in the central area of the cabin, so that the two crew members can read the information displayed and access the buttons. The bracket must be fixed with the arrows facing up and close to the control panel or dashboard, with the antenna and power cables reaching it from the bottom.



**Image 6. DEVICE INSTALLED ON THE CENTRAL AREA**

The equipment supplied by Al Kamel Systems must be powered from the vehicle's battery, whose voltage must be between 9V and 15V, and through a 3A fuse. It is **strictly forbidden to connect the power supply with reversed polarity**, as stipulated in the diagram shown below, and to install any switch or circuit breaker between the equipment and the battery:

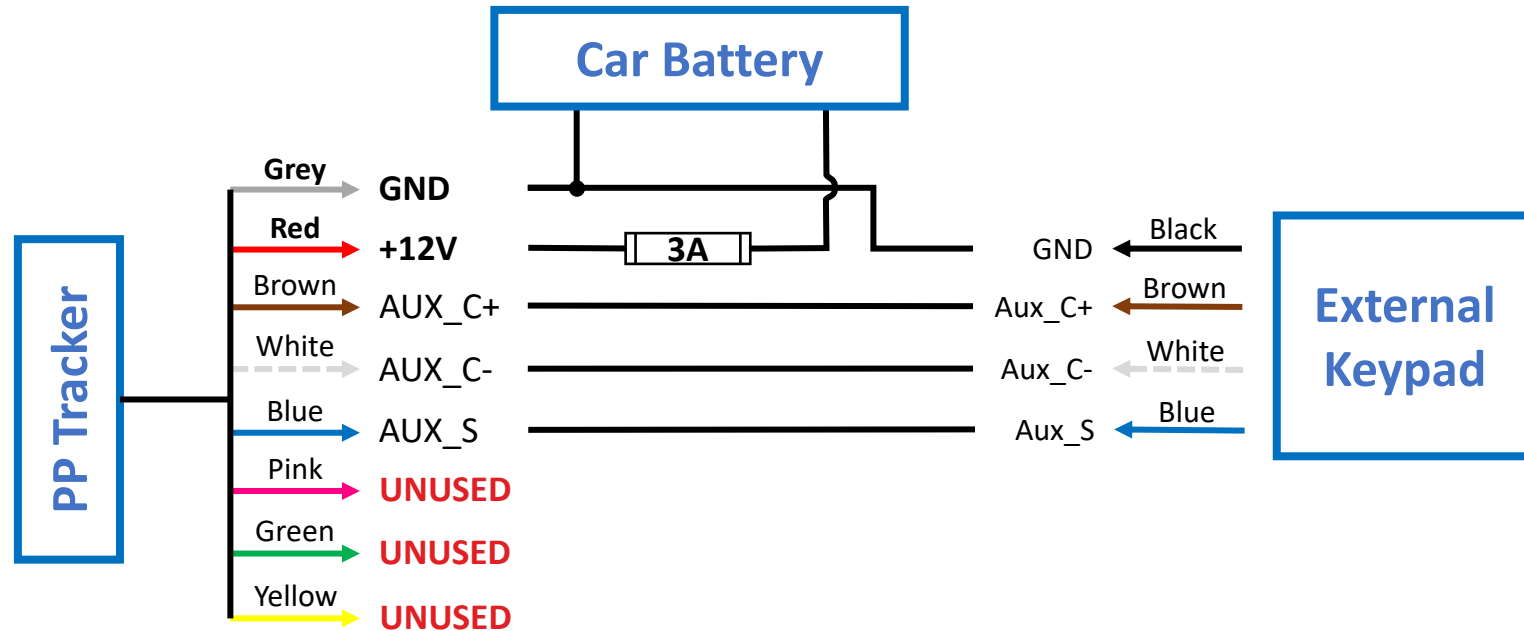





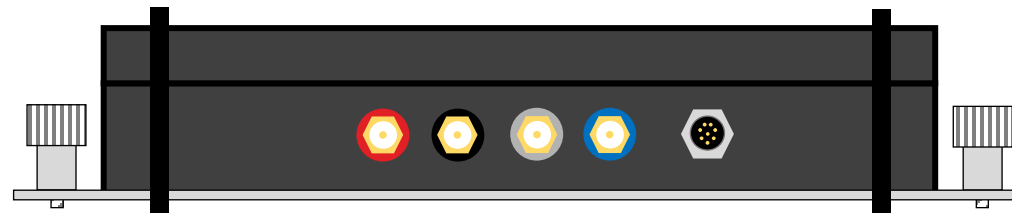

Image 7. PPTRACKER WIRING DIAGRAM

The ends of the cables that are not used cannot touch each other, for this it is recommended to make an oblique cut.

The equipment supplied by Al Kamel Systems must be connected according to the following scheme in the order indicated:

-  1. Connect the antenna cable marked **RED**
-  **BLACK** antenna built into the deviceAntena
-  UNUSED
-  2. Connect the antenna cable marked **AZUL**
-  3. Connect the **POWER** cable



**Image 8. PPTRACKER TERMINAL CONNECTIONS DIAGRAM**



The equipment supplied by Al Kamel Systems will must be mounted on the Metallic Bracket (Ref. AKS 4069) using a PH2 screwdriver to fix the 4 screws that are present on the PPTracker device:

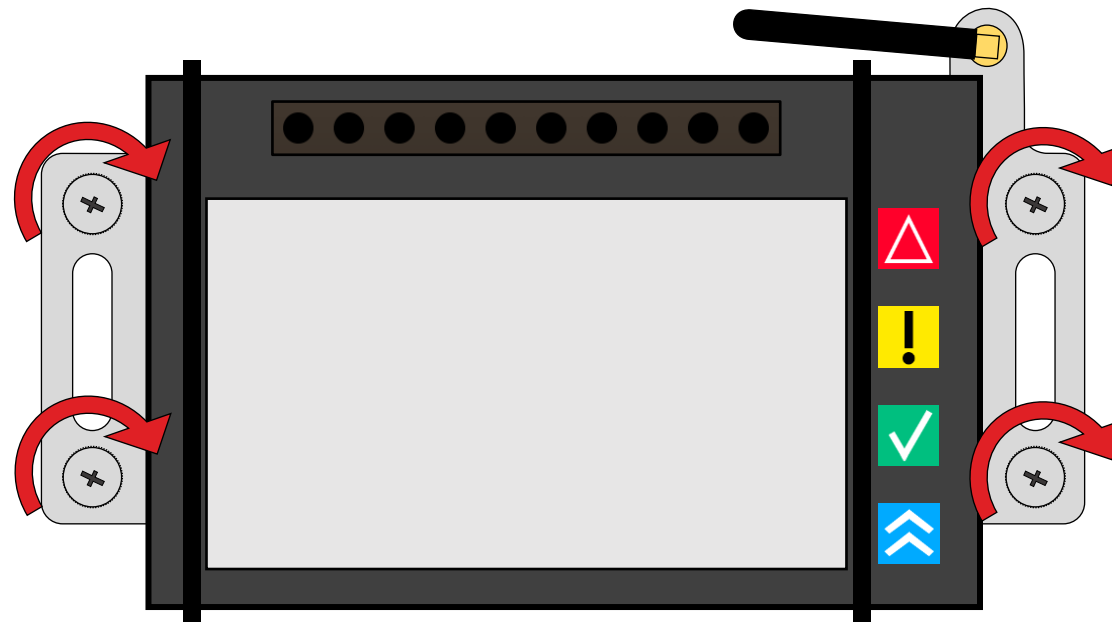

**Image 9. PPTRACKER BRACKET MOUNTING**

Before checking, make sure that you have followed all the steps indicated above and also make sure that the vehicle is located in an outdoor area clear of any type of obstacle, especially if it is metallic. Steps to verify correct installation of the device:

1. Turning on the device: the device turns on a few seconds after starting to receive power from the battery through the power cable.
2. Device charging: The device is charging if icon **1** appears blue or the screen is brighter.
3. Connection with race control: the device is correctly connected with race control if the 4 stripes are shown on icon **2**.
4. Satellite positioning: the device is geolocated when icon **3** appears.

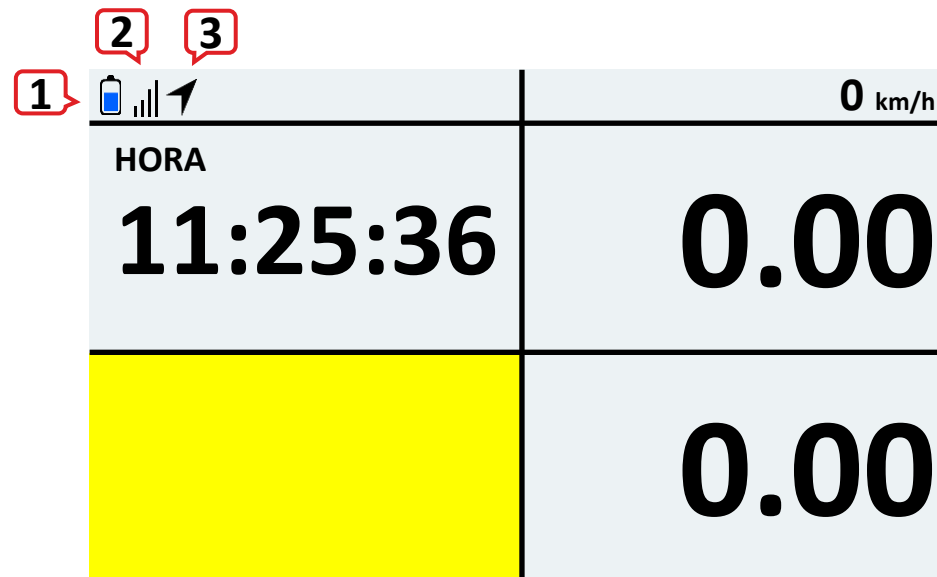
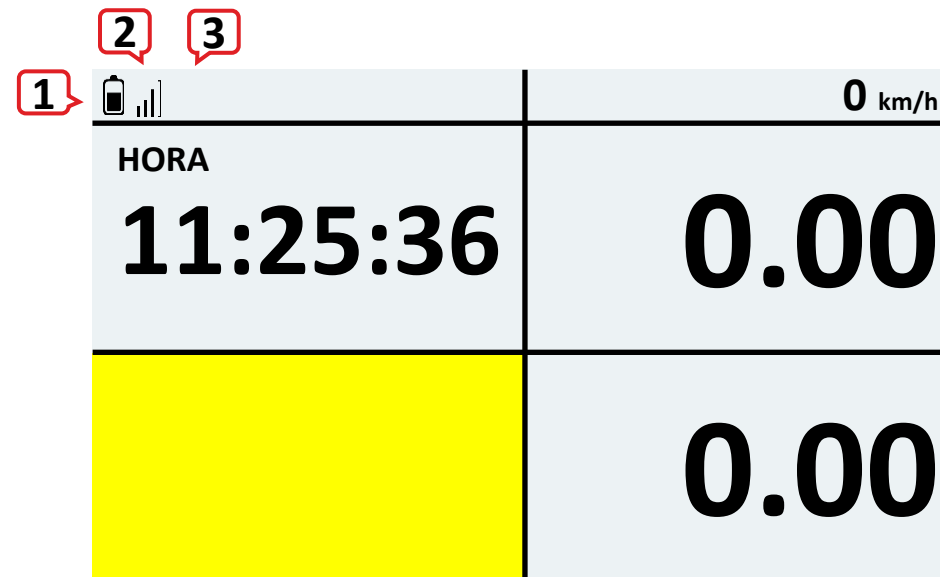

Image 10. PPTRACKER MAIN SCREEN

- Make sure you have installed the antenna in the center area of the exterior of the bodywork.
- Make sure that the vehicle is in a completely clear place with no obstacles to the sky.
- Make sure that the antenna cables are connected according to their corresponding color and the power cable is correctly connected.
- If the screen does not light up or the **1** icon does not appear blue, ensure that the power cable is connected directly to the vehicle battery only interrupted by a 3A fuse.
- If the four lines are not displayed on icon **2** or icon **3** is not displayed, wait 1 minute and check the correct condition and installation of the antenna cables.



**Image 11. PPTRACKER MAIN SCREEN WARNINGS**

For any other questions please send an email to the following address: [info@alkamelsystems.com](mailto:info@alkamelsystems.com)

We solve our clients' matters.

Al Kamel Systems S.L.

Tel: +34 935 100 480

Email: [info@alkamelsystems.com](mailto:info@alkamelsystems.com)



**AL KAMEL**  
S Y S T E M S

